

挤压角铝

70x70x9-135°

材质	表面处理	切面处理	特殊用途
铝合金	阳极氧化	无处理	Clean Room

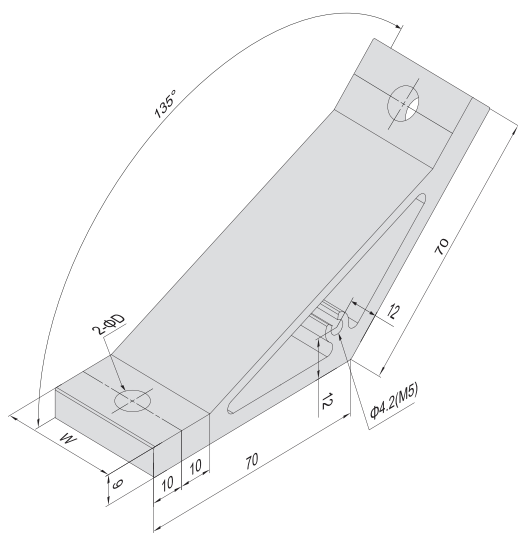

应用	产品描述	D (mm)	W (mm)	紧固组件	加工代码	重量 (g)	订购编号
30 系列 30mm	70-30-30 单个供货	7	22	2xA17	M5	71	CC-70-3030
	70-30-30 (成套供货)					94	CC-70-3030-A17
	70-30-30 (加工供货)					71	CC-70-3030-M5
	70-30-30 (成套加工供货)					96	CC-70-3030-M5-ST
40 系列 40mm	70-40-40 单个供货	9	30	2xA06	M5	96	CC-70-4040
	70-40-40 (成套供货)					142	CC-70-4040-A06
	70-40-40 (加工供货)					96	CC-70-4040-M5
	70-40-40 (成套加工供货)					144	CC-70-4040-M5-ST
45 系列 45mm	70-45-45 单个供货	9	35	2xA06	M5	113	CC-70-4545
	70-45-45 (成套供货)					159	CC-70-4545-A06
	70-45-45 (加工供货)					113	CC-70-4545-M5
	70-45-45 (成套加工供货)					161	CC-70-4545-M5-ST
50 系列 50mm	70-50-50 单个供货	9	40	2xA06	M5	131	CC-70-5050
	70-50-50 (成套供货)					177	CC-70-5050-A06
	70-50-50 (加工供货)					131	CC-70-5050-M5
	70-50-50 (成套加工供货)					179	CC-70-5050-M5-ST

■紧固组件

A06	A14	A17	M5
内六角圆柱头螺钉 M8x20	内六角平圆头螺钉 M5x10	内六角圆柱头螺钉 M6x16	
平垫圈 Φ8	平垫圈 Φ5	平垫圈 Φ6	
T 形螺母 M8	-	T 形螺母 M6	

A 铝型材

B 紧固件

C 连接件

D 型材附件

E 地面组件

F 护罩和围栏系统组件

G 门窗组件

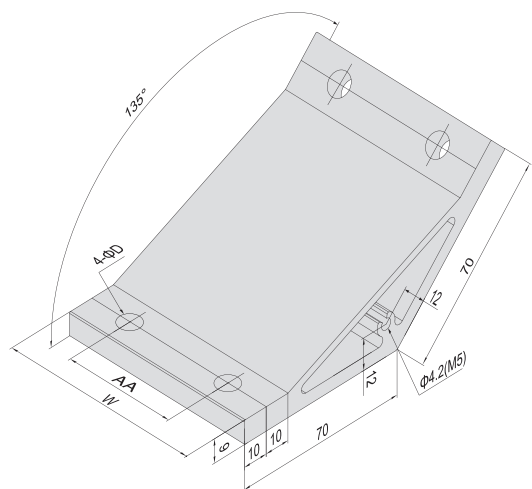

应用	产品描述	D (mm)	W (mm)	AA (mm)	紧固组件	加工代码	重量 (g)	订购编号
30 系列 60mm	70-30-60 单个供货	7	52	30	4xA17	M5	171	CC-70-3060
	70-30-60 (成套供货)						213	CC-70-3060-A17
	70-30-60 (加工供货)						171	CC-70-3060-M5
	70-30-60 (成套加工供货)						215	CC-70-3060-M5-ST
40 系列 80mm	70-40-80 单个供货	9	70	40	4xA06	M5	227	CC-70-4080
	70-40-80 (成套供货)						313	CC-70-4080-A06
	70-40-80 (加工供货)						227	CC-70-4080-M5
	70-40-80 (成套加工供货)						315	CC-70-4080-M5-ST
45 系列 90mm	70-45-90 单个供货	9	80	45	4xA06	M5	262	CC-70-4590
	70-45-90 (成套供货)						348	CC-70-4590-A06
	70-45-90 (加工供货)						262	CC-70-4590-M5
	70-45-90 (成套加工供货)						350	CC-70-4590-M5-ST
50 系列 100mm	70-50-100 单个供货	9	90	50	4xA06	M5	297	CC-70-50100
	70-50-100 (成套供货)						383	CC-70-50100-A06
	70-50-100 (加工供货)						297	CC-70-50100-M5
	70-50-100 (成套加工供货)						385	CC-70-50100-M5-ST

■紧固组件

A06	A14	A17	M5
内六角圆柱头螺钉 M8x20	内六角平圆头螺钉 M5x10	内六角圆柱头螺钉 M6x16	
平垫圈 Φ8	平垫圈 Φ5	平垫圈 Φ6	
T 形螺母 M8	-	T 形螺母 M6	

挤压角铝





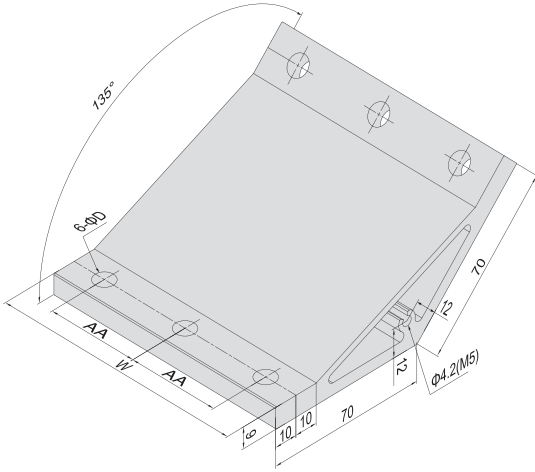



70x70x9-135°

材质	表面处理	切面处理	特殊用途
铝合金	阳极氧化	无处理	Clean Room

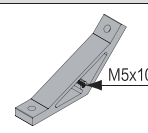

应用	产品描述	D (mm)	W (mm)	AA (mm)	紧固组件	加工代码	重量 (g)	订购编号
30系列 90mm 	70-30-90 单个供货	7	82	30			270	CC-70-3090
	70-30-90 (成套供货)				6xA17		331	CC-70-3090-A17
	70-30-90 (加工供货)					M5	270	CC-70-3090-M5
	70-30-90 (成套加工供货)				6xA17+1xA14	M5	333	CC-70-3090-M5-ST
40系列 120mm 	70-40-120 单个供货	9	110	40			357	CC-70-40120
	70-40-120 (成套供货)				6xA06		487	CC-70-40120-A06
	70-40-120 (加工供货)					M5	357	CC-70-40120-M5
	70-40-120 (成套加工供货)				6xA06+1xA14	M5	489	CC-70-40120-M5-ST





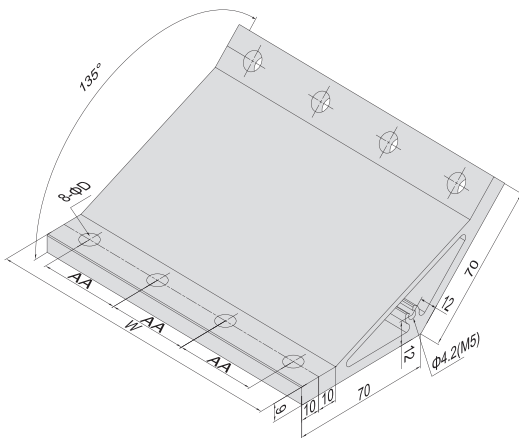



■ 紧固组件

A06	A14	A17	M5
 内六角圆柱头螺钉 M8x20	 内六角平圆头螺钉 M5x10	 内六角圆柱头螺钉 M6x16	
 平垫圈 Φ8	 平垫圈 Φ5	 平垫圈 Φ6	
 T形螺母 M8	-	 T形螺母 M6	

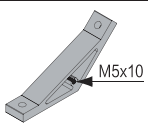

应用	产品描述	D (mm)	W (mm)	AA (mm)	紧固组件	加工代码	重量 (g)	订购编号
30系列 120mm 	70-30-120 单个供货	7	112	30			369	CC-70-30120
	70-30-120 (成套供货)				8xA17		449	CC-70-30120-A17
	70-30-120 (加工供货)					M5	369	CC-70-30120-M5
	70-30-120 (成套加工供货)				8xA17+1xA14	M5	451	CC-70-30120-M5-ST
40系列 160mm 	70-40-160 单个供货	9	150	40			488	CC-70-40160
	70-40-160 (成套供货)				8xA06		660	CC-70-40160-A06
	70-40-160 (加工供货)					M5	488	CC-70-40160-M5
	70-40-160 (成套加工供货)				8xA06+1xA14	M5	662	CC-70-40160-M5-ST
45系列 180mm 	70-45-180 单个供货	9	170	45			558	CC-70-45180
	70-45-180 (成套供货)				8xA06		730	CC-70-45180-A06
	70-45-180 (加工供货)					M5	558	CC-70-45180-M5
	70-45-180 (成套加工供货)				8xA06+1xA14	M5	732	CC-70-45180-M5-ST

■ 紧固组件

A06	A14	A17	M5
 内六角圆柱头螺钉 M8x20	 内六角平圆头螺钉 M5x10	 内六角圆柱头螺钉 M6x16	
 平垫圈 Φ8	 平垫圈 Φ5	 平垫圈 Φ6	
 T形螺母 M8	-	 T形螺母 M6	